

# Data Sheet

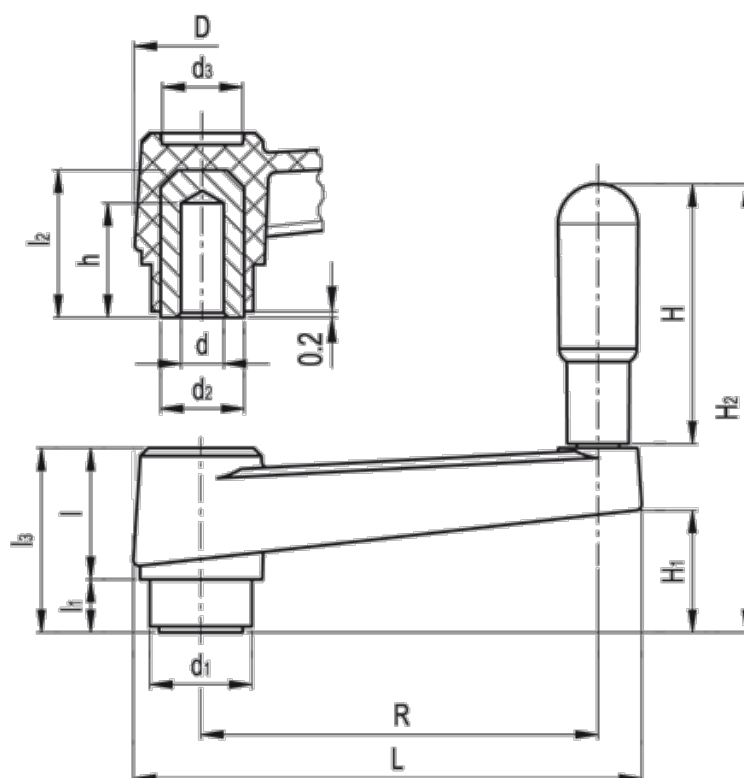

Article number: 2301044513  
Description: E+G Crank handle  
MT.160-AT

## Measures



D	= 45	H2	= 137
d1	= 34.0	l	= 40
d2	= 26	L	= 197
d3	= 27	l1	= 15
d H7	= 16	l2	= 43
H	= 80	l3	= 55
h	= 30	R	= 160
H1	= 38.0	Weight (g)	= 300